

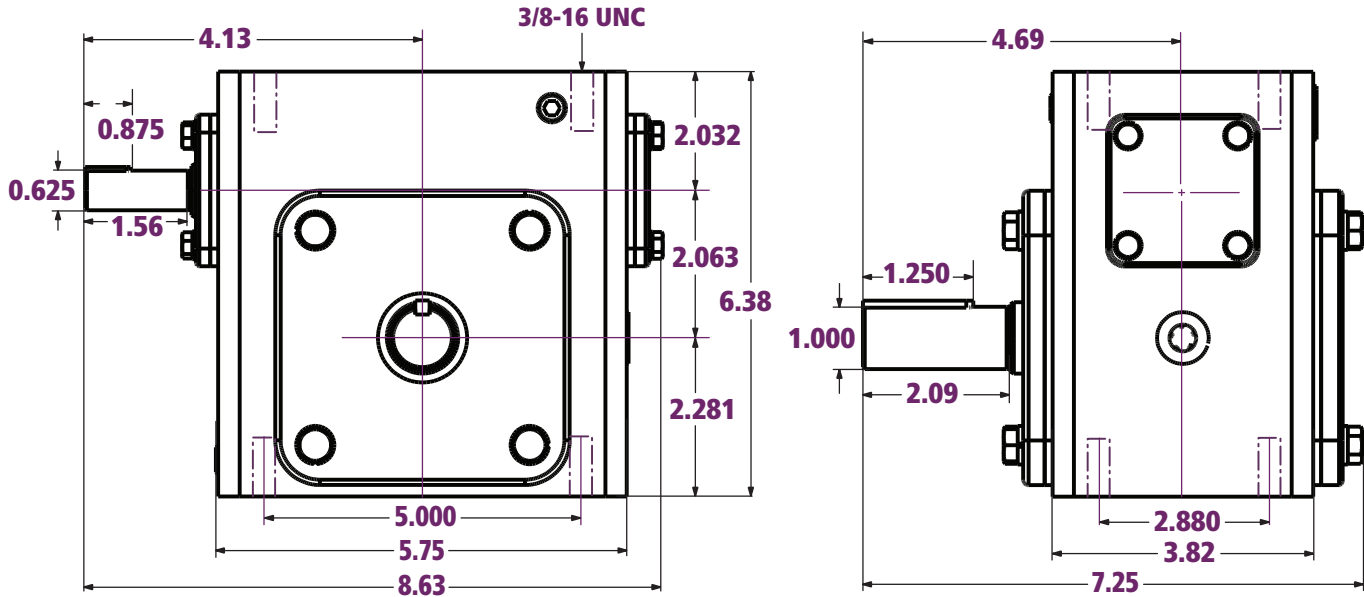

XS206 Dimensions

All dimensions listed in inches



Output and Input Shafts (in)

Output Keyway (in)	Output Shaft Dia. (in)	Input Keyway (in)	Input Shaft Dia. (in)
1/4 x 1/8	1.000	3/16 x 3/32	0.625

Specifications

Center Distance (in)	Weight (lbs)	Est. Oil Fill Amount* (oz)
2.063	27.5 [28.6 [†]]	17.3

*For Position 1.

[†]Approximate weight for LR Handling.

Ratios

Nominal Ratios	Exact Ratios
5:1	5.8:1
10:1	10.3:1
15:1	15.5:1
20:1	19.5:1
30:1	30.0:1
40:1	40.0:1
50:1	50.0:1
60:1	60.0:1

Efficiency

Nominal Ratios	Efficiency (%)
5:1	≈ 92
10:1	≈ 90
15:1	≈ 85
20:1	≈ 82
30:1	≈ 73
40:1	≈ 71
50:1	≈ 62
60:1	≈ 58

Handling Types

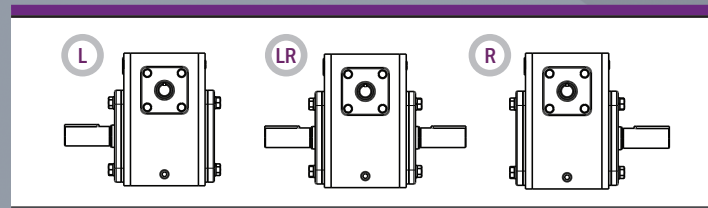

XS206 Accessories

and X206 Base Kit Dimensions

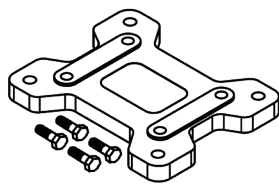
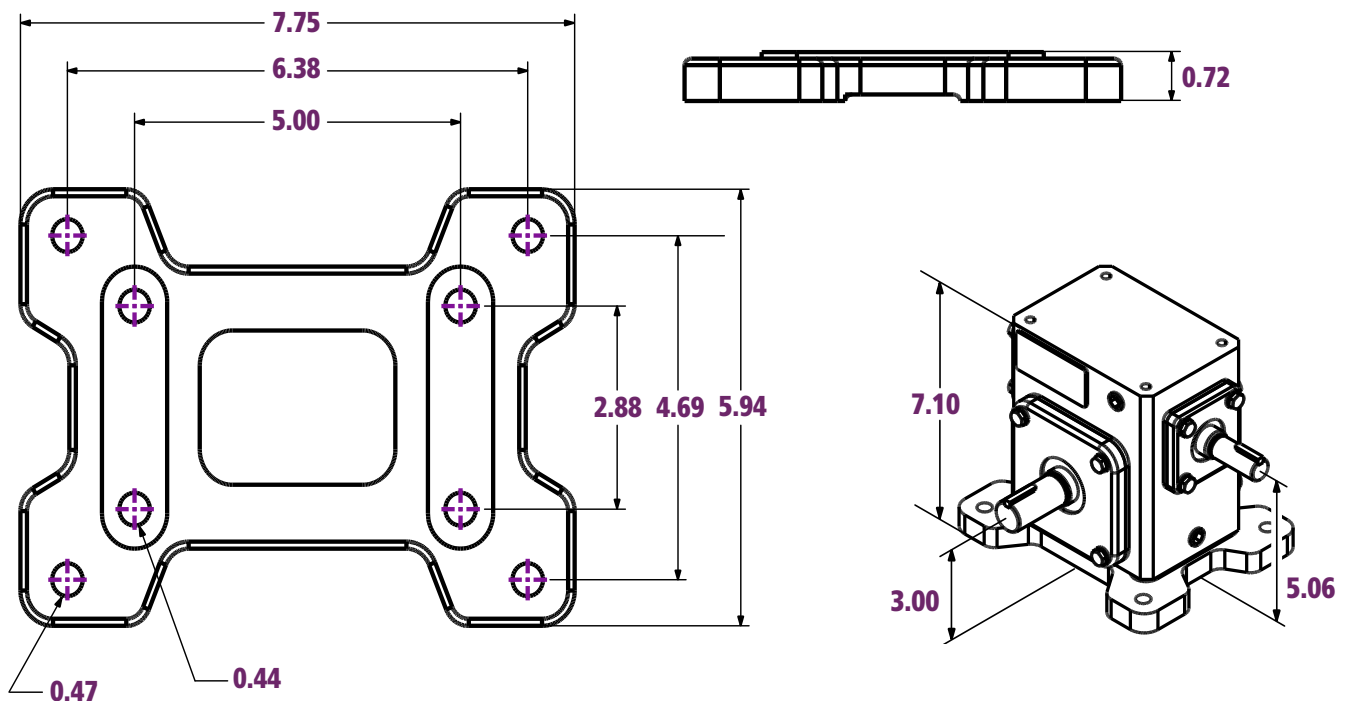

Foot Mounted Base Kit

XBK206



Component Repair Kit

XSRK206

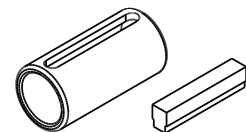

Input Quill Adapter Option

Not Applicable

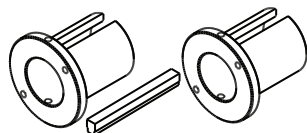

Output Bushing Kits*

Not Applicable

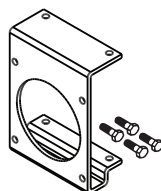

Output Bracket Kit*

XOB206

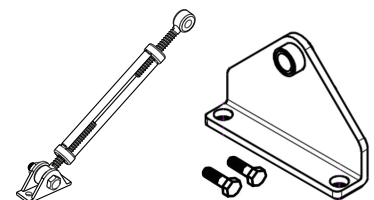

Torque Arm Kit*

XTA206

*Made to order.